



Creating Ideas for  
**WORKSPACE**



**INNOVATION  
EXCELLENCE  
QUALITY  
GROWTH**



Making offices a better place to work - is our goal. Factors such as furniture, space utilisation, lighting, noise management, temperature control and transparency influence the productivity of the employees

# At **Mecwill** DESIGN IS THE KEY !!



IN HOUSE CREATIVE  
DESIGN TEAM



IN HOUSE TEAM OF  
INTERIOR DESIGNERS



MADE TO MEASURE  
DESIGN ORDERS



3D & 2D TECH. DESIGN  
AND SOFTWARES



EXPRESS DESIGN  
APPROVAL SERVICE



CONTEMPORARY  
DESIGNS



MANY READY DESIGNS  
TO ORDER & SHIP FROM



SITE MEASUREMENT  
TEAM & SUPERVISORS



HIGH PRECISION  
CALCULATIONS













Smart, Intelligent, Versatile Yet Scalable, **Mecwill** Furniture  
is Nicely Designed to Create Collaborative Spaces  
for Large Shared Work Environments as well as small offices

# Compliance and Certifications



## What Makes Us Efficient ?

We understand that furnishing your office is more than just buying furniture. It's about creating an efficient workspace that reflects your company's values and goals. That's why we pride ourselves on being reliable and committed to providing further innovations in office furniture.

 <p><b>Organisation Structure</b> We ensure continuous upgrading knowledge learning skills of our team.</p>	 <p><b>Manufacturing Setup</b> Inhouse manufacturing setup for all types of designer furniture and modern soft furnishing.</p>	 <p><b>Production Capabilities</b> We have made theme based customised design and furniture in 3.5 Lakh sq. ft. commercial space.</p>
 <p><b>Pan-India Presence</b> We deliver our products all across India.</p>	 <p><b>Customisation Capability</b> Designer and execution as per Customer's needs.</p>	 <p><b>Environmentally</b> Green Manufacturing practices.</p>
 <p><b>Vocal for Local</b> An initiative under the Aatma Nirbhar Bharat Abhiyan. The world is looking at India as a manufacturing powerhouse.</p>	 <p><b>Make in India</b> Proud to manufacture all solutions in India.</p>	 <p><b>Finance Available</b> Secure Payments and EMI options available to suit your needs.</p>
 <p><b>Fully Insured</b> All Works and Employees are covered by our Comprehensive Company Insurance.</p>	 <p><b>Competitive Pricing</b> We have wide selection of ranges available to suit every budget.</p>	 <p><b>Gurantee/Warranty</b> All products comes with a manufacturer's Gurantee/Warranty from 1 to 10 years.</p>

**17** | YEARS  
ANNIVERSARY  
CELEBRATION

## **Who Are we?**

### **Meet the Mecwill India Team : A Symphony of Talent**

Our team comprises a diverse ensemble of skilled artisans, innovative designers, and client-centric professionals. Each member brings unique expertise and passion of excellence, contributing to the extraordinary tapestry that is Mecwill India. We believe that our people are our most valuable asset, and their collective spirit fuels our success.

Our approach blends the art of design with the science of ergonomics, resulting in remarkable office spaces that are as comfortable as they are captivating. We begin with a thorough understanding of our client's needs, followed by a meticulous design process that focuses on aesthetics, functionality and as well-being. Our manufacturing facilities use cutting-edge technology and sustainable materials, ensuring that our products stand the test of time.

## Workstation desk

finest design crafted with the best possible material.

The modular workstation desk from Mecwill India is a versatile and highly functional piece of office furniture that is designed to meet the unique needs of your business. This desk features a modular design that allows for easy reconfiguration and expansion, ensuring that it can adapt to changing business needs over time. The desk is also highly ergonomic, with an adjustable height and ample storage space, to help keep your employees comfortable and organized. Whether you're looking to optimize your workspace, improve efficiency, or create a professional and stylish work environment, Mecwill India's modular workstation desk in india is the perfect solution.

# Workstation

desk series

## The right choice for exceptional workspaces

We design and develop open plan office systems for all kinds of corporate, MNCs and PSU offices. Open office system offers high level of space optimisation, greater transparency, better collaboration and effective performance. Our internationally appealing minimalistic design is both stylish and cost-effective. Scalability, flexibility, easy installation, shifting and re-configuration are some of the advantages of modular furniture.

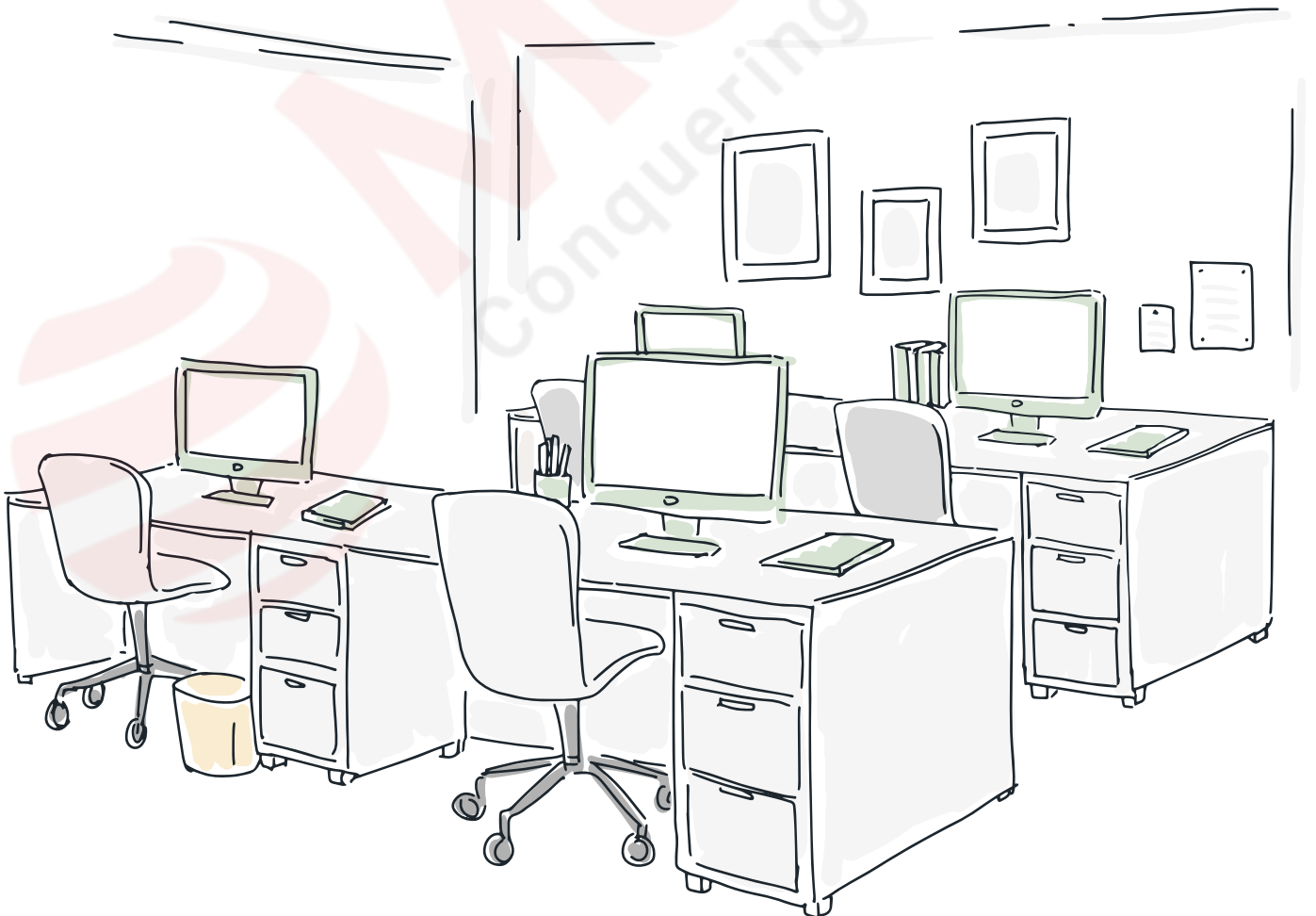





Code : **M-CLW 121**

Color Range :



1002  
Mangfall Beech



10175  
Asian Mapple



10091  
Nova Teak



11005  
Neo Highland Pine



Code : **M-CLW 122**

Color Range :



1002  
Mangfall Beech



10175  
Asian Mapple



10091  
Nova Teak



11005  
Neo Highland Pine



Code : **M-CLW 123**

Color Range :



1002  
Mangfall Beech



10175  
Asian Mapple



10091  
Nova Teak



11005  
Neo Highland Pine



Code : **M-CLW 124**  
Color Range :

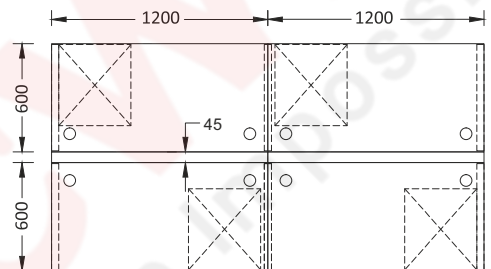

Code : **M-CLW 125**  
Color Range :

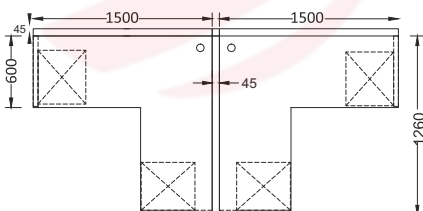



Code : **M-CLW 126**  
Color Range :

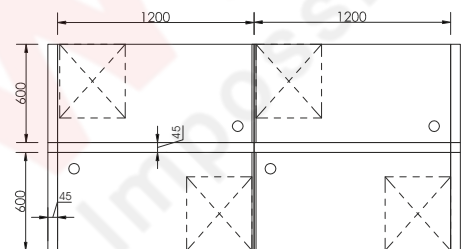

Code : **M-CLW 127**  
Color Range :

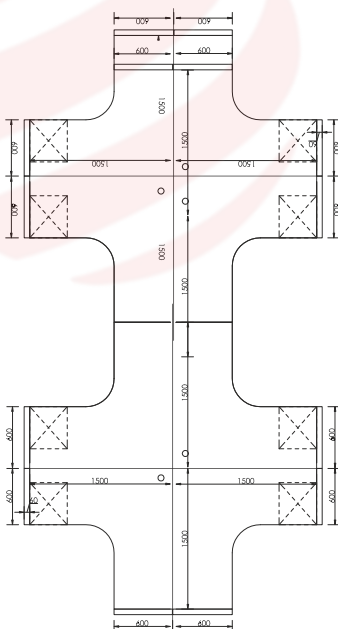
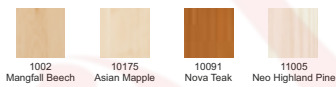



Code : **M-CLW 128**  
Color Range :

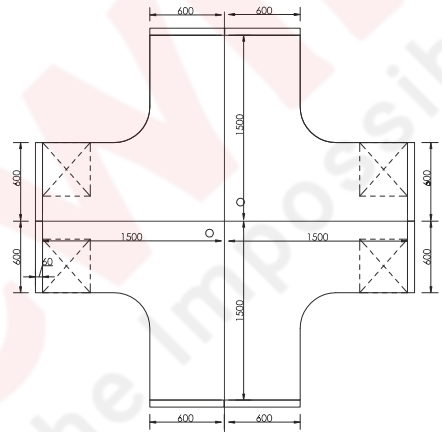

Code : **M-CLW 129**  
Color Range :

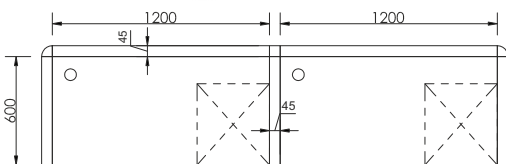



Code : **M-CLW 130**  
Color Range :

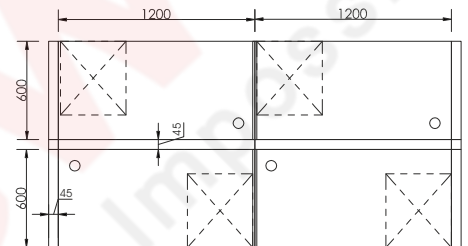
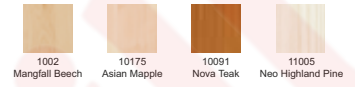

Code : **M-CLW 131**  
Color Range :

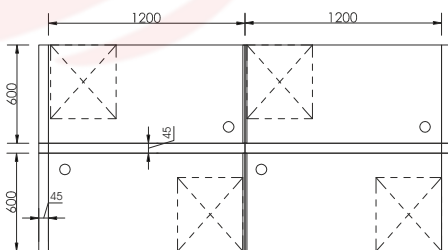
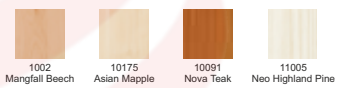



Code : **M-CLW 132**  
Color Range :

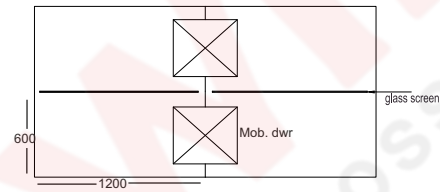

- Back to Back Workstation
- 1200/1050/900 x 600mm
- CRCA Powder coated under structure
- CRCA Powder coated raceway
- 32mm/ 45mm screen/ 8 mm
- Lacquered Glass Screen with Mobile Drawer
- Side divider glass/ partition based

Code : **M-CLW 133**  
Color Range :

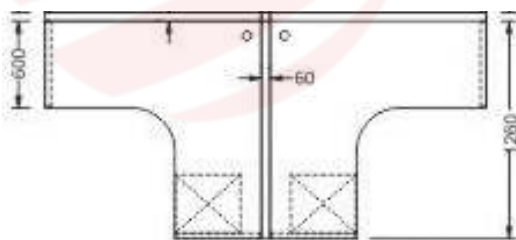

W3060 X D1860 X H1200





Code : **M-CLW 134**  
Color Range :

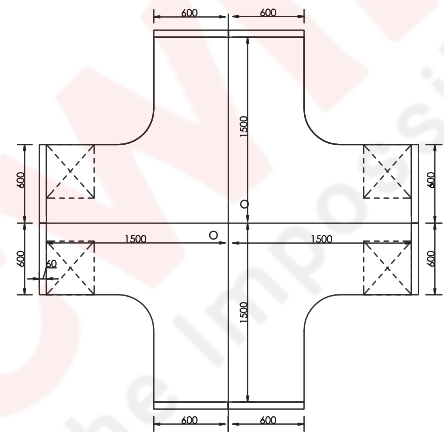

Code : **M-CLW 135**  
Color Range :

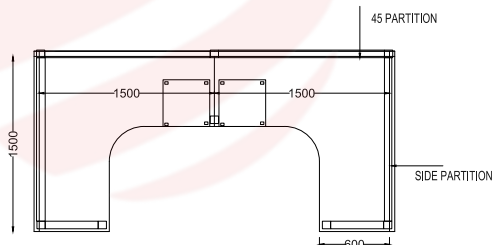
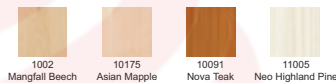

- L shape workstation
- 1200/1050/900 x 600mm
- CRCA Powder coated under structure
- CRCA Powder coated raceway
- 32mm/ 45mm screen/ 8 mm
- Lacquered glass screen with fixed mobile drawer
- Side divider glass/ partition based



Code : **M-CLW 136**  
Color Range :

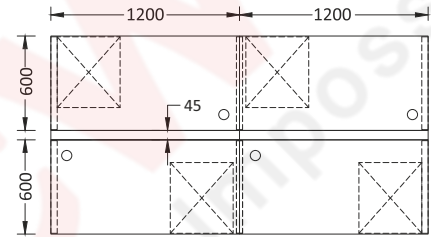

Code : **M-CLW 137**  
Color Range :

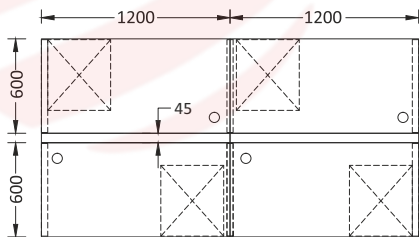





Code : **M-CLW 138**  
Color Range :

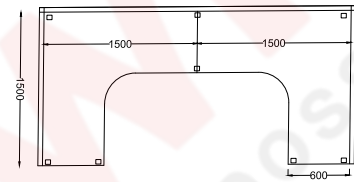

- ➔ L shape workstation
- ➔ 1200/1050/900 x 600mm
- ➔ CRCA Powder coated under structure
- ➔ CRCA Powder coated raceway
- ➔ 32mm/ 45mm screen/ 8 mm
- ➔ Lacquered glass screen
- ➔ Side divider glass/ partition based

Code : **M-CLW 139**  
Color Range :

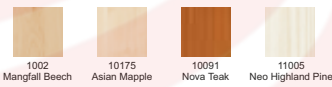



Code : **M-CLW 140**  
Color Range :

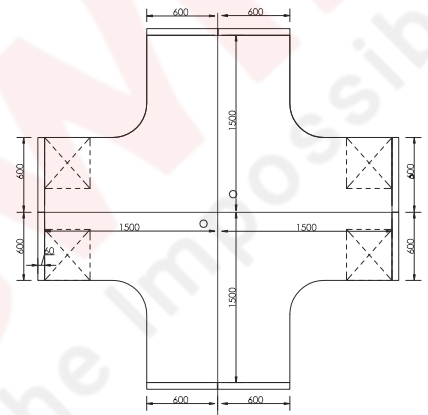

Code : **M-CLW 141**  
Color Range :

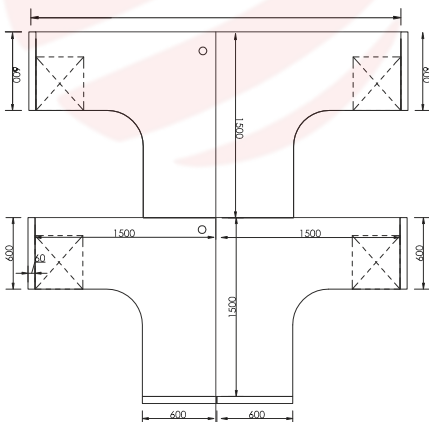



Code : **M-CLW 142**  
Color Range :

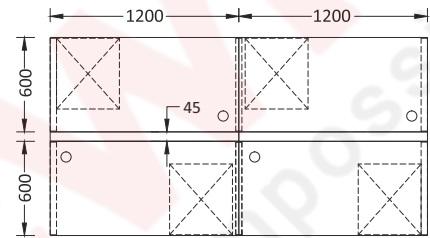

Code : **M-CLW 143**  
Color Range :

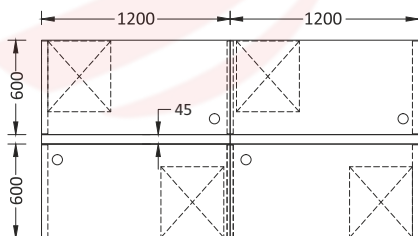



Code : **M-CLW 143**  
Color Range :

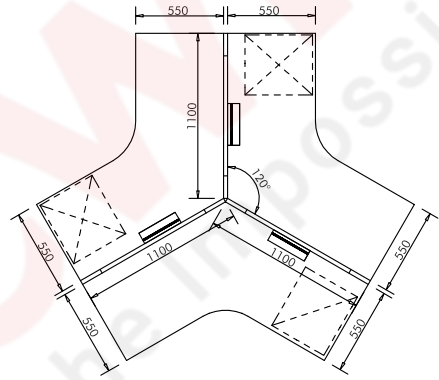
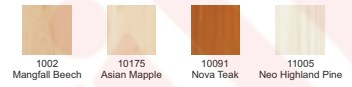

Code : **M-CLW 144**  
Color Range :

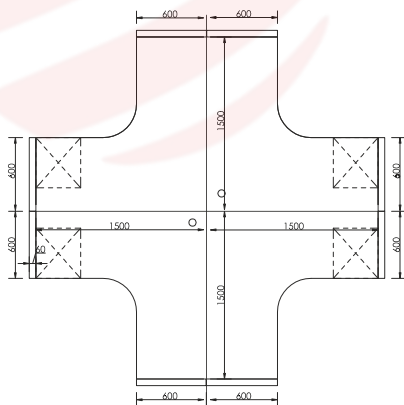



Code : **M-CLW 145**  
Color Range :

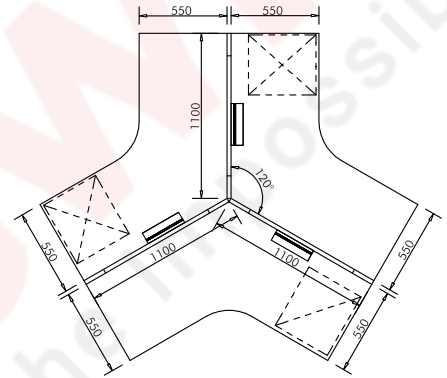

Code : **M-CLW 146**  
Color Range :

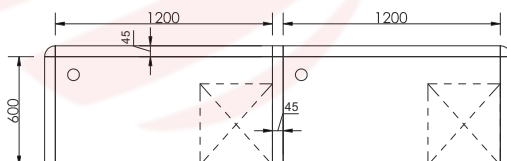
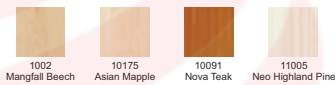



Code : **M-CLW 147**  
Color Range :

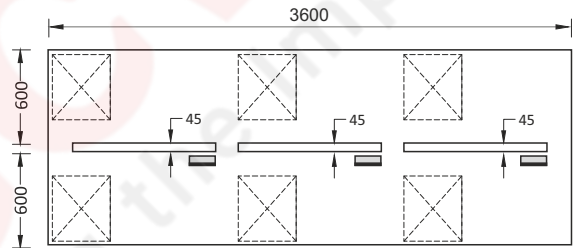
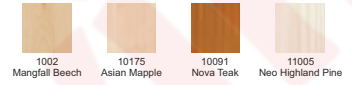

Code : **M-CLW 148**  
Color Range :

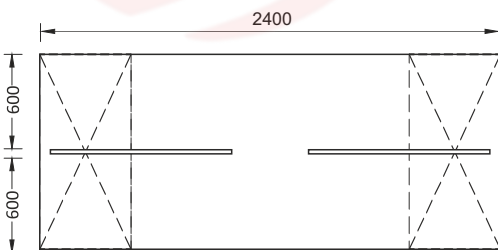



Code : **M-CLW 149**  
Color Range :

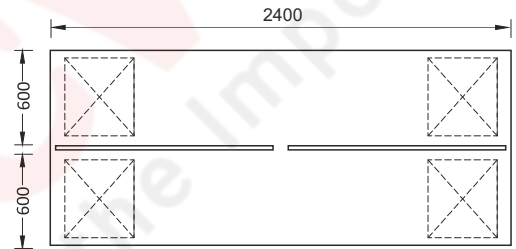

Code : **M-CLW 150**  
Color Range :

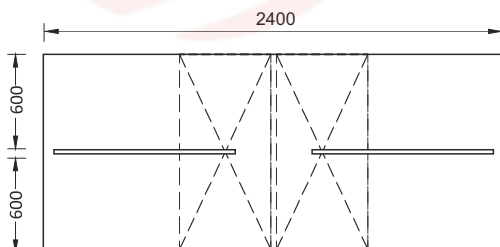



Code : **M-CLW 151**  
Color Range :

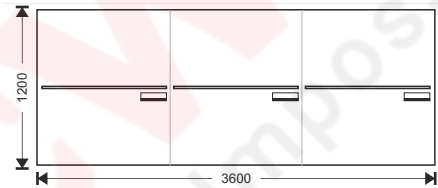

Code : **M-CLW 152**  
Color Range :

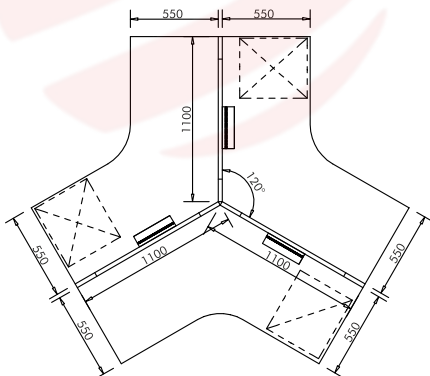





Code : **M-CLW 153**  
Color Range :

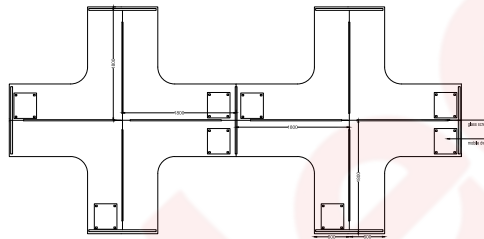

- Cluster Workstation
- 1200/1050/900 x 600mm
- CRCA Powder coated under structure
- CRCA Powder coated raceway
- 32mm/45mm screen/8mm
- Lacquered glass screen with Mobile Drawer
- Side divider glass/ partition based

Code : **M-CLW 154**  
Color Range :

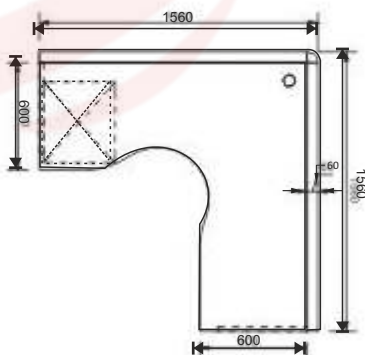



Code : **M-PBW 155**  
Color Range :

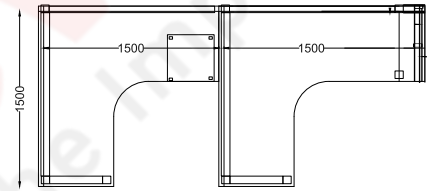
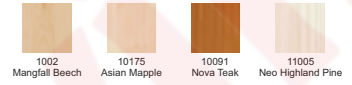

Code : **M-PBW 156**  
Color Range :

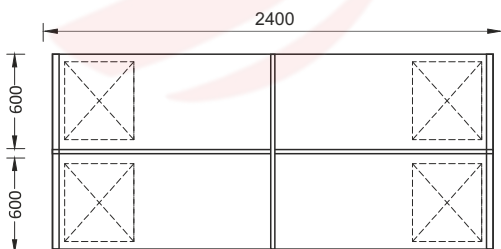



Code : **M-PBW 157**  
Color Range :

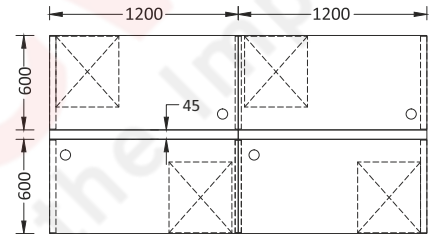

Code : **M-PBW 158**  
Color Range :

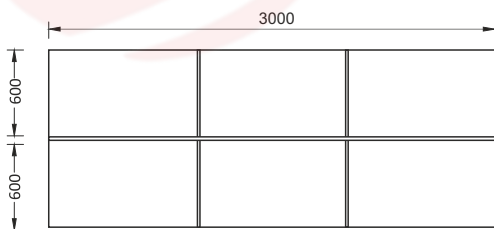



Code : **M-PBW 159**

Color Range :

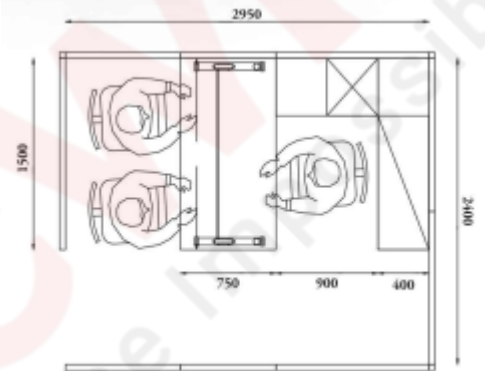

Code : **M-PBW 160**

Color Range :

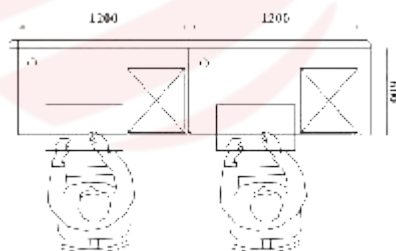
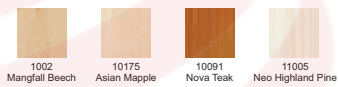



Code : **M-PBW 161**  
Color Range :

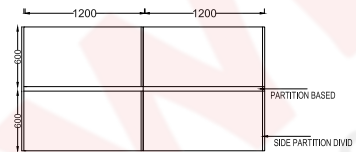

- Back to Back Workstation
- 1200/1050/900 x 600mm
- Aluminum Powder coated raceway
- 45mm/60mm screen partition with fabric /
- White marker board
- Side divider glass/ partition based

Code : **M-PBW 162**  
Color Range :

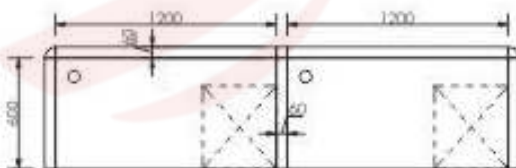



Code : **M-PBW 163**  
Color Range :

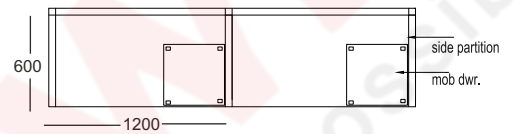

- Single Side (linear) Workstation
- 1200/1050/900 x 600mm
- Aluminum Powder coated raceway
- 45mm/60mm screen partition with fabric/
- White marker board with pencil drawer
- Mobile drawer
- Side divider glass/ partition based

Code : **M-PBW 164**  
Color Range :

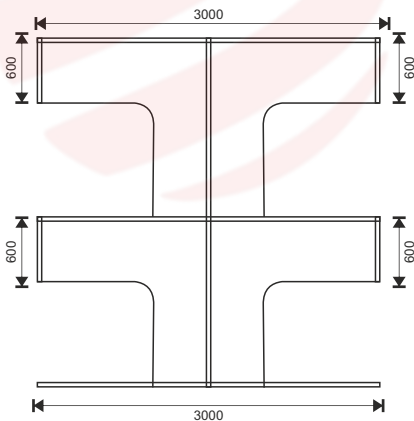
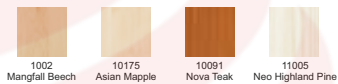



Code : **M-PBW 165**  
Color Range :

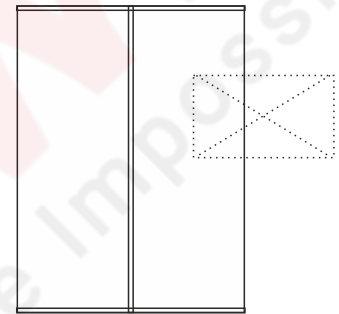

Code : **M-PBW 166**  
Color Range :

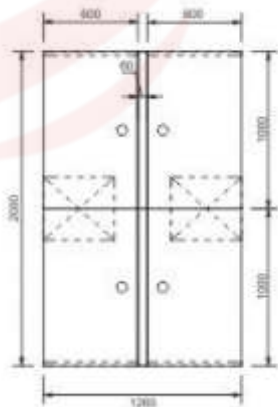



Code : **M-PBW 167**  
Color Range :

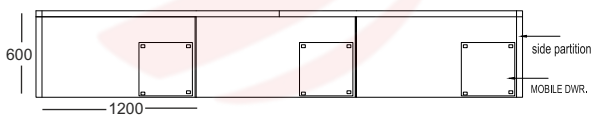
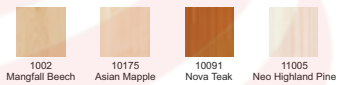

- Single Side (linear) Workstation
- 1200/1050/900 x 600mm
- Aluminum Powder coated raceway
- 45mm/60mm screen partition with fabric/
- White marker board with pencil drawer
- Mobile Drawer
- Side divider glass/ partition based





Code : **M-PBW 168**  
Color Range :

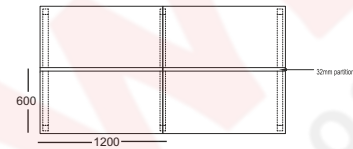

- Back to Back Workstation
- 1200/1050/900 x 600mm
- CRCA Powder coated under structure
- CRCA Powder coated raceway
- 32mm/ 45mm screen/ 8 mm
- Lacquered Glass Screen
- Side divider glass/ partition based

Code : **M-PBW 169**

Color Range :

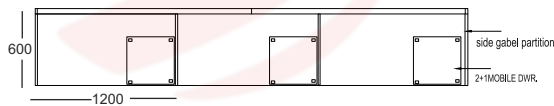
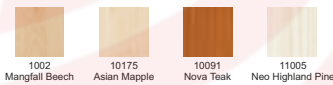

- Single Side (linear) Workstation
- 1200/1050/900 x 600mm
- Aluminum Powder coated raceway
- 45mm/60mm screen partition with fabric/
- White marker board with pencil drawer
- Mobile Drawer
- Side divider glass/ partition based



Code : **M-PBW 170**

Color Range :

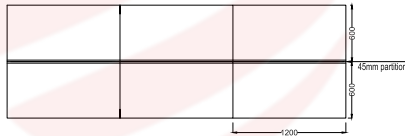

- ➔ Back to Back Workstation
- ➔ 1200/1050/900 x 600mm
- ➔ Aluminum Powder coated raceway
- ➔ 45mm/60mm screen partition with fabric /
- ➔ White marker board
- ➔ Lacquered Glass Screen with Mobile drawer
- ➔ Side divider glass/ partition based



Code : **M-PBW 171**  
Color Range :

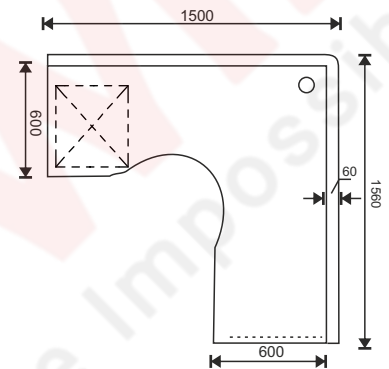

Code : **M-PBW 172**  
Color Range :

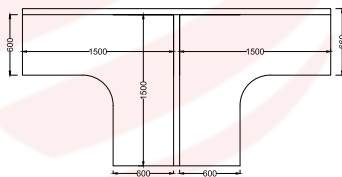

- ➔ L shape workstation
- ➔ 1200/1050/900 x 600mm
- ➔ CRCA Powder coated under structure
- ➔ CRCA Powder coated raceway
- ➔ 32mm/ 45mm screen/ 8 mm
- ➔ Lacquered glass screen
- ➔ Side divider glass/ partition based



Code : **M-PBW 173**  
Color Range :

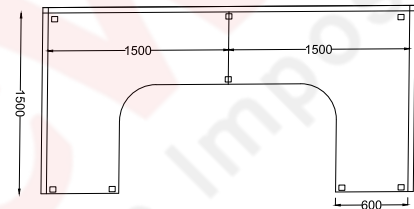

Code : **M-PBW 174**  
Color Range :

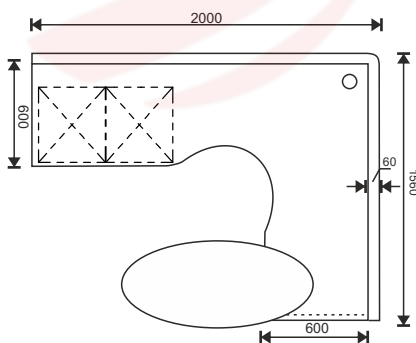



Code : **M-PBW 176**  
Color Range :

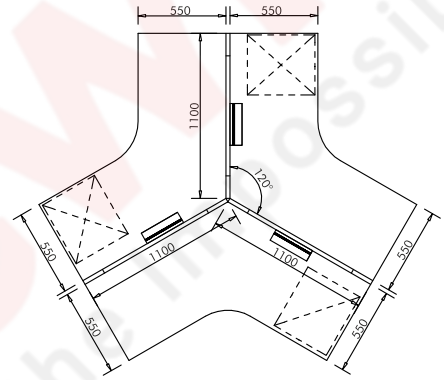

Code : **M-PBW 177**  
Color Range :

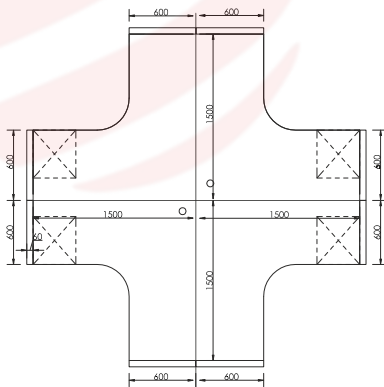

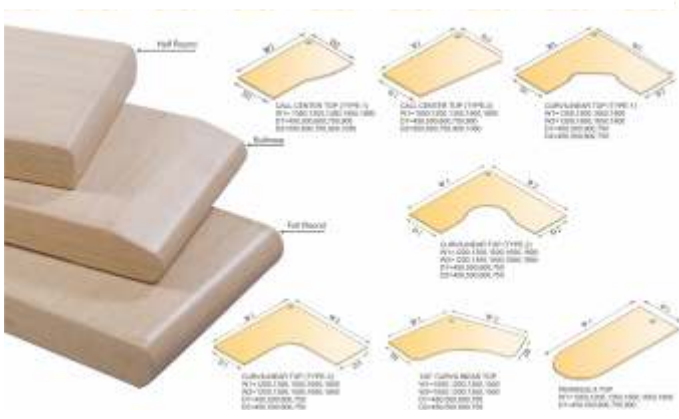

CLUSTER OPTIONS

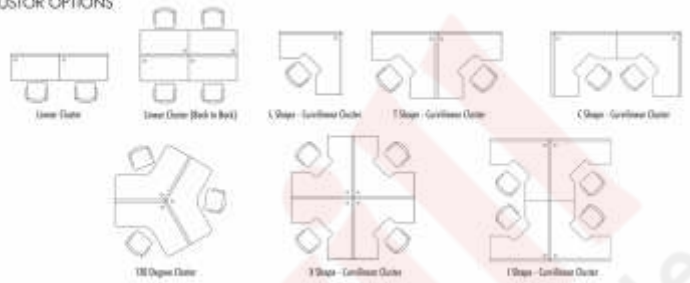

GABLE OPTIONS

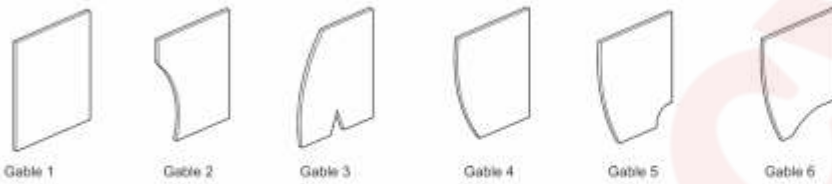

Design & Specifications are subject to change without prior notice.  
 All sizes mentioned are in MM.  
 Accessories & props (Chair etc.) shown in the pictures are not part of product.

Accessories



Flaper



Metal keyboard tray



Flip box



1



2

Desktop Socket



Laminated keyboard tray



Metal CPU Trolley



Wire manager cap



Round pole leg



I leg



Vertebrae -1



Reducing leg



10002 Mangfall Beech    10175 Asian Mapple    11005 Neo Highland Pine    10091 Nova Teak    22091 Arctic White    21059 Platinum



10858 Wenge    10012 Oxford Cherry    10699 Mahogany    22099 Slate    10145 Red Oxford Cherry    10007 Douglas Pine



10036 White Beech    11192 Neo Bavarian Beech    10544 Canadian Walnut    10031 Fine Oak    10848 Straight Walnut DX    10019 Sapelle

\*(For DX shade rate will be charged extra.)

## Powder Coats



Black    Ivory    White    Chocolate Brown    Moon Grey    Silver Grey    Bone Grey    D.A. Grey

## Fabrics



Med Blue (F191)    Acorn (F 128)    Caramel (F 132)    China Sea (MS 407)    Roman Green (MS 440)    Lavender (MS 416)    Dago Orange (F 181)    Spearment (F 102)



Flame (F 123)    Attenzione (MS 419)    Fresco (MS 420)    Cinnamon (MS 422)    Cream Blue (NE 801)    Cement Yellow (NE 817)    Beige Pacific Blue (NE 803)    Salmom (MS 425)



Reflection (MS 438)    Vesuvius (MS 410)    Gold Blue (NE 821)    Wine Blue (NE 822)    Blue (NE 824)    Granada (MS 452)    Mink (MS 449)    Dark Forest (MS 437)

The secret of Mecwill's customisation possibilities is the innovatively design under structure and its capability of separating, handling and managing large number of electrical and data cables, making wire management simple and trouble-free.

## Privacy Screens



28mm thick with frame:  
Fabric / Laminate /  
Marker / Magnetic /  
Soft Pinup

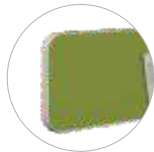

25/33mm thick with  
aluminium trim:  
Fabric / Laminate /  
Magnetic / Soft Pinup

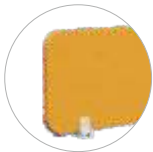

18mm thick with gasket:  
Fabric / Magnetic

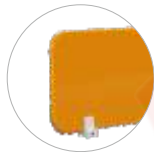

8mm thick:  
Sandwich Glass



## Table Tops

### Finshes

Pre / Post laminate:  
Straight edge; 25mm thick

Membrane Top:  
Chamfered edge; 25mm thick

Postform Edge Profile:  
Round-27mm thick, Waterfall-25mm thick

### Dimensions

#### Linear

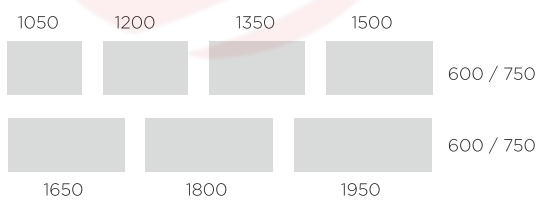

#### Curvi-Linear

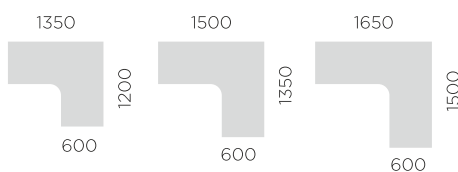

#### 120°

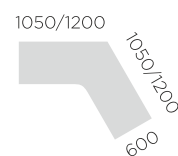

All dimensions in mm





Hock: CRCA pipe 50x60



Fusion: 45 extruded aluminium dual colour



Splayed: CRCA square pipe 40x40



Heel: CRCA 50x60

Access Flap



300/450 X 120



Tubular: CRCA Pipe, 50 diameter, 40 horizontal square pipe



Loop: CRCA Triangular Pipe 40X40X57



Linear: CRCA Square pipe 50 vertical, 40 horizontal pipe

Cabin Table Configurations

Table Tops



W 1500 / 1650 / 1800 / 1950 / 2100  
D 750 / 900

W 1800 / 1950 / 2100  
D 1050

Side Storages



W 900 / 1050 / 1200  
D 450

Back Storages



W 1050 / 1200 / 1350 / 1500 / 1650 / 1800  
D 450

Storage Configurations



2 shutter storage



2 shutter storage  
2 book drawer



3 shutter storage



2 shutter storage  
2 book drawer  
1 file drawer

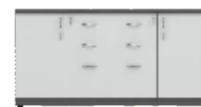

2 shutter storage  
4 book drawer  
2 file drawer



2 shutter storage  
2 open shelf

Meeting Tables

Conference Tables



L: 3000, 3750, 4500, 5400,  
6000, 6750  
W: 1200, 1500

Discussion Tables



L: 1500, 1800, 2400  
W: 1200, 1500



ø 750, 900, 1050,  
1200, 1350, 1500

Pedestals



Metal 1 box + 1 file  
392W x 450D x 550H



1 box + 1 file  
with fabric cushion  
392W x 450D x 610H



2 box + 1 file  
392W x 450D x 680H

Pre-lam 1 box + 1 file  
406W x 459D x 550H

1 box + 1 file  
with fabric cushion  
406W x 459D x 610H

2 box + 1 file  
406W x 459D x 680H

Trust **Mecwill** Office Furniture  
to experience comfort like never Before...

Manufactured & Marketed by:

**ZIFFMEC INDIA PRIVATE LIMITED**

📍 C-127, Block C, Sector-10, Noida (U.P.)

☎ +91-120-3265651

🌐 [www.mecwill.com](http://www.mecwill.com)

For feedback or queries write email us at:

✉ [sales@mecwill.com](mailto:sales@mecwill.com) | [service@mecwill.com](mailto:service@mecwill.com)  
[info@mecwill.com](mailto:info@mecwill.com) | [reachus@mecwill.com](mailto:reachus@mecwill.com)



**Sales Support** : +91-9717090474

**Service Care** : +91-9717090498



Associate Franchise Partner